



WC431 Slimline Integrated Dishwasher

Manual for Installation, Use and Maintenance

Contents

Contents.....	2
Important.....	3
Important Notes.....	4
Recommendations	6
Before First Use.....	6
Control Panel.....	7
Detergent.....	10
Salt.....	12
Softener Adjustment	13
Rinse Aid.....	15
Dishwasher Baskets.....	16
Standard Loading and Test Data	18
Programme Listing.....	19
Care and Maintenance.....	20
Failure Codes and Troubleshooting.....	22
Electrical Information.....	24
Installation.....	26
Fitting the Integrated Appliance Door.....	27

Important

The CDA Group Ltd cannot be held responsible for injuries or losses caused by incorrect use or installation of this product. Please note that CDA reserve the right to invalidate the guarantee supplied with this product following incorrect installation or misuse of the appliance or use in a commercial environment.

This appliance is not designed to be used by people (including children) with reduced physical, sensorial or mental capacity, or who lack experience or knowledge about it, unless they have had supervision or instructions on how to use the appliance by someone who is responsible for their safety.

Under no circumstances should any external covers be removed for servicing or maintenance except by suitably qualified personnel.

Appliance information:

Please enter the details on the appliance rating plate below for reference, to assist CDA Customer Care in the event of a fault with your appliance and to register your appliance for guarantee purposes.

Appliance Model	<input type="text"/>
-----------------	----------------------

Serial Number	<input type="text"/>
---------------	----------------------

This appliance has been designed for domestic use only. Commercial use will invalidate the warranty

CE Declarations of Conformity:

This appliance has been designed, constructed and marketed in compliance with safety requirements of EEC Directives 2004/108/EC, 2006/95/EC, IEC436/DIN44990 & EN 50242.

Availability of this manual in an alternative format:

A soft copy of this manual is available for download from www.cda.eu.

IMPORTANT INFORMATION FOR CORRECT DISPOSAL OF THE PRODUCT IN ACCORDANCE WITH EC DIRECTIVE 2002/96/EC.

At the end of its working life, the product must be taken to a special local authority waste collection centre or to a dealer providing appliance recycling services.

Disposing of a household appliance separately avoids possible negative consequences for the environment and health. It also enables the constituent materials to be recovered, saving both energy and resources. As a reminder of the need to dispose of household appliances separately, the product is marked with a crossed-out wheeled dustbin.

Important Notes

- Read the instructions prior to installation and use of the appliance.
- Do not lean or climb on the open dishwasher door to prevent damage.
- Close the dishwasher door after use to prevent accidents.
- Use only detergents, salt and rinse aid specifically designed for dishwashers.
- Do not put solvents in the dishwasher detergent compartment to prevent risk of explosion
- Only put dishwasher safe items into the dishwasher. If in doubt, check with the manufacturer of the items.
- Take care when loading the dishwasher to observe the recommendations for best loading practice, and also to ensure that sharp objects such as knives are placed blade down to prevent accidents.

- Do not open the dishwasher door when a programme is running. If it is necessary to do so, then open it only slightly to allow the dishwasher to pause the programme and prevent any water spilling out. Remember that the water in the dishwasher can be very hot when the programme is running.
- When the dishwasher is not in use, we recommend that you turn off the water supply at the supply tap and disconnect the main supply.
- If you are leaving the dishwasher for an extended period you should leave the door slightly open to prevent the formation of unpleasant smells.
- The plastic housing on the water inlet pipe contains an electrically operated valve. The wires that connect to this valve are inside the inlet hose. Do not cut through the inlet hose, and do not put the plastic housing in water.
- Children could get locked inside the appliance. Therefore when disposing of an old appliance, cut off the plug and set aside, and damage the door lock so that the door can no longer be closed.
- This appliance can be used by children aged from 8 years and above and persons with reduced physical, sensory or mental capabilities or lack of experience and knowledge if they have been given supervision or instruction concerning use of the appliance in a safe way and understand the hazards involved. Children shall not play with the appliance. Cleaning and user maintenance shall not be made by children without supervision.

Recommendations

- To reduce energy and water consumption, remove all dirt residues from the dishes prior to loading the dishwasher.
- Only run the dishwasher when fully loaded.
- Place hollow items (bowls, glasses and pans) face down in the basket.
- Do not put dishes or cutlery with tobacco ash, wax, lubricating grease or paint residues in the dishwasher.

Before First Use

- Set the water softener level as required by the water hardness in the area.
- Add 1kg of salt into the salt compartment and then fill with water to the top of the salt compartment.
- Remove all the packaging materials from the interior of the dishwasher.
- Fill the rinse aid compartment.
- Run a hot programme without any dishes in the dishwasher.

Control Panel

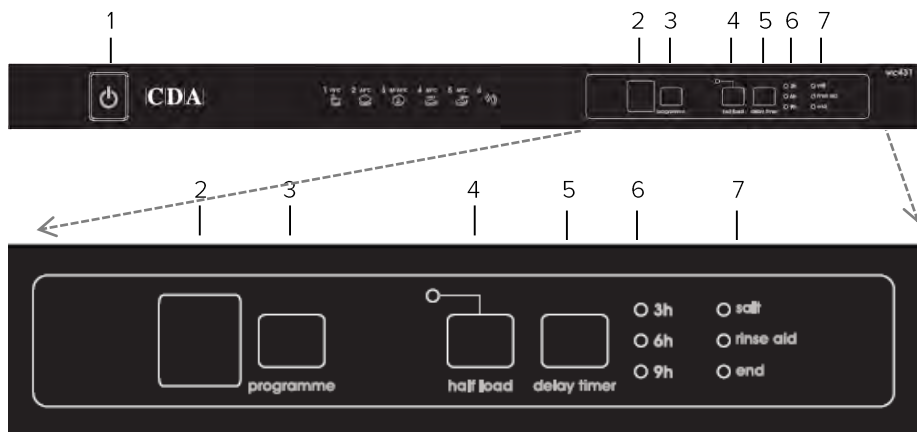

Power Button (1)

To switch the dishwasher on or off, press the power button (1). When you switch on the dishwasher, the end of programme light will illuminate, and two dashes will appear on the display.

Programme Display (2)

The programme display shows the selected programme and the remaining time to run. If there is a fault on the dishwasher, the fault code will show on the display.

Programme Selection Button (3)

To select a programme, press the programme selection button (3). The dishwasher will store in its memory the last programme used.

Half-Load Button (4) and Indicator Light

The dishwasher is equipped with a half-load function that allows for small numbers of dishes to be washed, spread between both baskets. This reduces the amount of water and electricity used.

- To use this function, press the half-load button (4), the indicator light shows to indicate that this function is selected.

If you have selected the half-load function for a programme, this function will automatically be selected the next time the dishwasher is used. To cancel the selection of this function, press the specific half load button (4) until the indicator light goes out.

Delay Timer Button (5)

The dishwasher is equipped with a variable timer of 3, 6 or 9 hours to delay the start of a programme.

- To set the delay timer, press the delay timer button (5). This will switch the timer on for 3 hours.
- Pressing the delay timer button (5) again will increase the delay to 6 hours, a third press increases the time to 9 hours. The delay time selected will show on the indicator lights (6).
- To cancel the delay timer, press the delay timer button again until none of the indicator lights (6) are lit.

Salt, Rinse Aid Warning Lights and End of Programme Light (7)

When the dishwasher salt or rinse aid begins to run out, the warning light will illuminate to advise that it needs refilling.

When the programme is complete, the dishwasher will emit five beeps and the end of programme indicator light will illuminate.

Starting a Programme

- Press the Power button (the end of programme light will be switched on)
- Press the Programme Selection button until the required programme is shown on the display.

- If required, set the delay timer by pressing the Delay Timer button
- Once a programme is selected, the end of programme light will switch off.
- When you close the dishwasher door, the programme will start automatically.

Please note: The dishwasher stores the most recently used programme in its memory. To change the programme, simply press the Programme Selection button.

At the End of a Programme

If possible, do not open the dishwasher door once the programme has started.

At the end of a programme, the dishwasher will beep five times, and the end of Programme Indicator light will switch on.

Changing a Programme

It is possible to change the programme if necessary once the programme has started.

- First open the door slightly to reduce the risk of water spillage.
- Press the programme selection button until the required programme is shown on the display.
- Then close the door. The dishwasher will begin the new programme from the point at which the old programme stopped.

Cancelling a Programme

It is possible to cancel the programme once it has started.

- First open the door slightly to reduce the risk of water spillage.
- Press and hold in the Programme Selection button for

three seconds until the end of programme indicator flashes and a “1” shows on the display.

- Then close the door. The dishwasher will run a drain cycle which will take approximately 30 seconds. Once this is complete, the dishwasher will beep five times and the end of programme light will switch on.

Switching the Dishwasher Off

Once the dishwasher beeps five times and the end of programme light switches on, the dishwasher can be switched off by pressing the Power button.

Then turn off the water tap and remove the plug from the power socket.

Please note: the dishwasher will automatically continue on the programme it has started if the door is opened or in the event of a power cut.

Detergent

To Fill the Detergent Compartment

1. Push the latch to open the compartment.
2. Add the required amount of detergent. The main detergent compartment “b” (figure 2) has lines to allow for specific amounts of detergent. These are marked at either 15 cm³ or 25 cm³, to be used depending on how dirty the dishes are. If your dishes are in need of an intensive wash, then add 5 cm³ of detergent into the prewash section of the compartment “a” (figure 1).
3. Then close the detergent compartment lid until the latch locks.

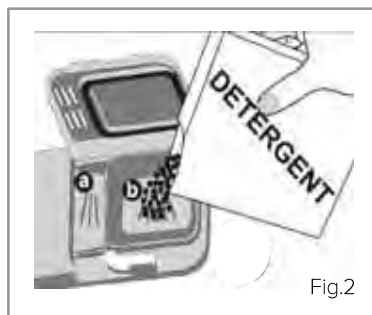

Please note: You should only use detergents designed specifically for use in dishwashers.

Combination detergents (e.g. 3-in-1 tablets) must not be used in any quick wash or half load programme.

If using dishwasher tablets, always use the detergent compartment, do not put them in the main body of the dishwasher or in the cutlery basket. The solubility of dishwasher tablets can vary depending on the temperature and duration of the programme. As a result, it is recommended that powder detergents should be used in the shorter programmes to allow better performance.

CDA recommends the use of separate detergent, rinse aid and dishwasher salt rather than combination tablets as separates achieve better wash performance.

If you do use combination detergents, add salt and rinse aid to the dishwasher and then adjust the water hardness setting and rinse aid setting to the minimum. When you then use separate detergents again, you should fill the salt and rinse aid compartments, adjust the water hardness setting to the maximum and run an empty wash, then adjust the water hardness setting and the rinse aid setting to the appropriate level.

Salt

To ensure the best efficiency, the dishwasher needs soft water. Hard water means that lime residues remain on the dishes and the interior of the dishwasher, affecting performance. The softener system is designed to remove the ions that make the water hard to provide the best quality wash performance. This is achieved by using dishwasher salt.

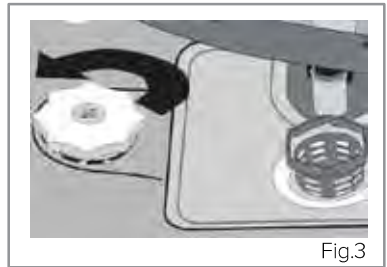

To Add Dishwasher Salt, Follow the Steps Below:

1. Remove the lower dishwasher basket and then unscrew the salt compartment cap, as shown in figure 3.
2. Fill the compartment with dishwasher salt (do not use table salt), carefully to prevent unnecessary spillage (figure 4). Before first use, you should fill the compartment with 1kg of dishwasher salt and then fill up the salt compartment with water (up to the brim of the compartment) as shown in figure 4.
3. Replace the cap and the lower basket.



When the salt warning light on the control panel illuminates, you should refill the salt compartment with salt only - do not add water to the salt compartment after the first use.

Important: You should run a prewash programme immediately after adding dishwasher salt, to prevent any damage to the dishwasher systems.

Only fill the salt compartment with water on first use.

Softener Adjustment

The efficiency of your dishwasher depends on the softness of the tap water.

To ensure best efficiency, the dishwasher is equipped with a system that reduces the hardness in the mains water supply. The efficiency will increase when the system is correctly set. To find out the water hardness level of your water supply you can use the test strip supplied or alternatively contact your local water board.

- Open the testing strip (figure 5).
- Run water through the tap for one minute.
- Hold the testing strip in water for one second.
- Remove from the water and shake the test strip to remove excess water.
- Wait for one minute.
- Check the number of marks on the strip to see the level of water hardness.

If the hardness of the water you use is above 63 dE or if you are using well water; you are recommended to contact your local water board to confirm the water hardness level and to use filter and water refinement devices.

Please note: The level of water hardness is preset to level 3.

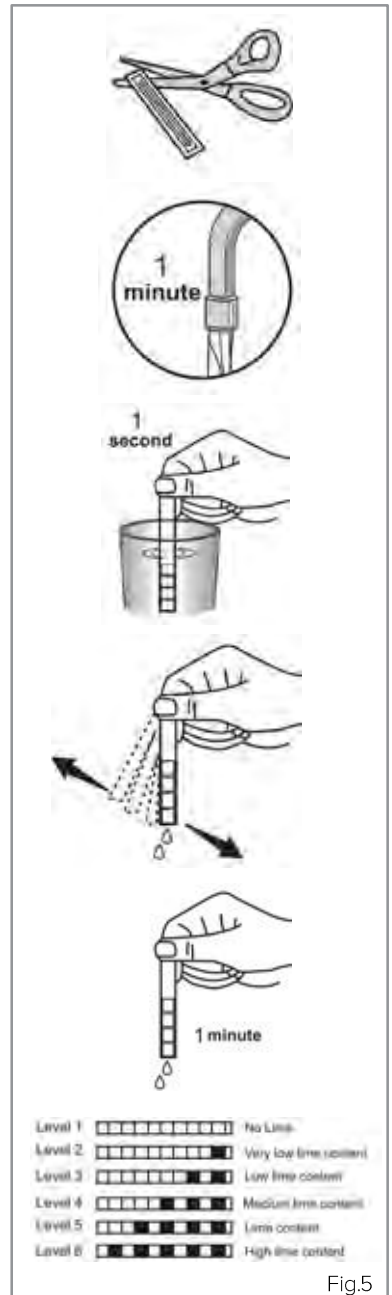

Fig.5

1. Press and hold down the programme selection button
2. Press the Power button to switch on the dishwasher
3. Keep the programme selection button pressed until “8” shows on the display and then disappears.
4. After the 8 disappears the machine displays the last water hardness setting entered.
5. To adjust the level, press the programme selection button (3) until the required level is shown on the display, as listed in the Table of Water Hardness below.
6. To store the selected water hardness level, press the power button.

Water Hardness Level	British Hardness dE	Display Shows
1	0 – 6	L1
2	7 – 14	L2
3	15 – 21	L3
4	22 – 28	L4
5	29 – 39	L5
6	40 - 63	L6

Rinse Aid

To Fill the Rinse Aid Compartment

1. Open the rinse aid compartment by turning and removing the cap as shown in figure 6.
2. Fill the rinse aid compartment until the rinse aid indicator goes dark, as shown in figure 7 (where “a” indicates the compartment is empty, and “b” indicates the compartment is full).
3. Replace the cap, ensuring the markers on the cap line up with the compartment prior to screwing the cap back in place.

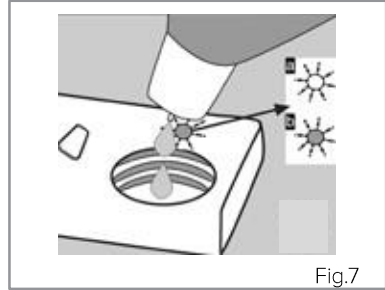
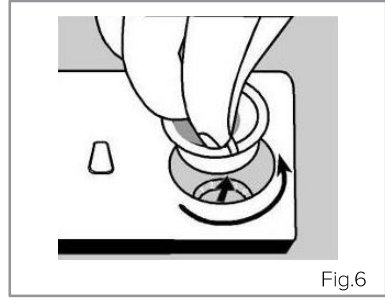

Rinse Aid Adjustment

The level of rinse aid use is preset to 3. You can adjust the level of rinse aid use by adjusting as shown in figure 8.

If water stains form on the dishes after a wash, the level should be increased.

If blue stains which can be wiped away are left on the dishes after a wash, the level should be decreased.

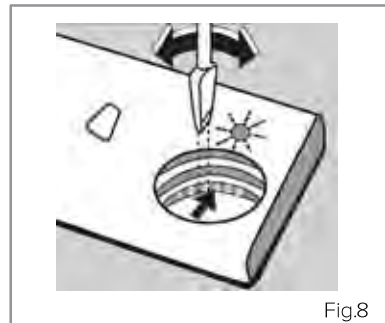

Please note: Rinse aid ensures better quality wash results and increased drying performance.

Always refill the rinse aid when the rinse aid indicator light on the control panel is illuminated.

Dishwasher Baskets

Top Basket Height Adjustment

The top basket of your machine is supplied in the upper position. When it is in this position, you can place big items such as pans, etc. on lower basket.

When you move the top basket to lower position, you can place and wash large plates on the top basket.

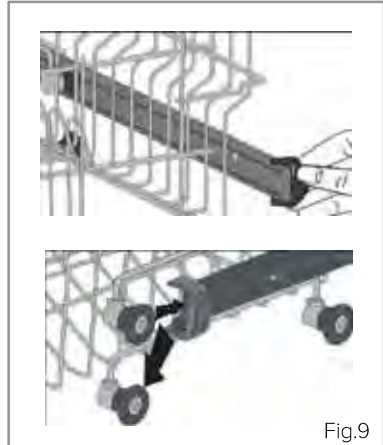

The basket height is adjusted by using the alternative wheel sets on the tracks:

1. Swing open the basket retainers (fig. 9).
2. Slide the basket forward off the rails.
3. Re-insert the other set of wheels into the rails.
4. Swing the basket retainers closed (fig.9).

The images below are designed as guidance as to best practice for loading the dishwasher.

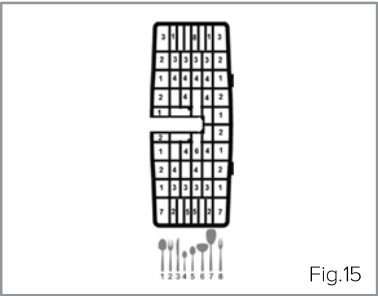
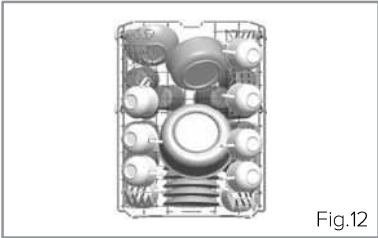
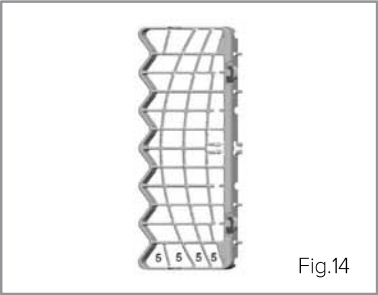
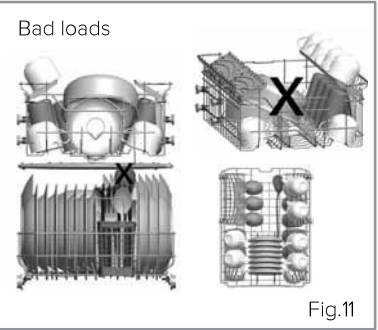
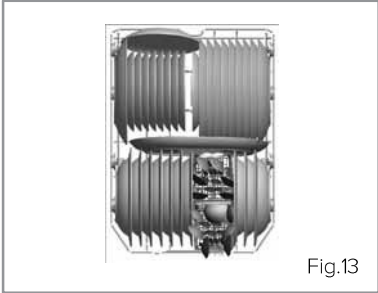
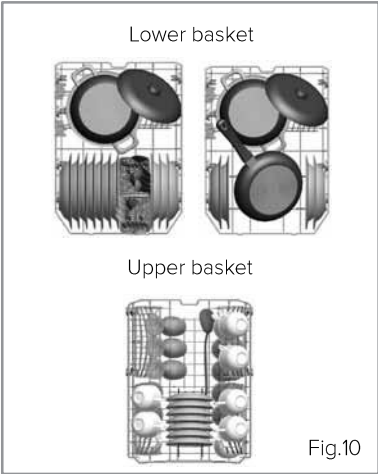

Standard Loading and Test Data

Capacity

- Upper and lower baskets: 10 place settings.
- The upper basket should be adjusted to high position.
- Cups should be placed on to the dish rack pins.

Detergent / Rinse Aid

- 5 + 20 cm³, in accordance with EN50242-DIN 44990 IEC 436 (international norms) / Rinse aid dosage adjustment: 4.

Programme Test

- Eco 50°C, in accordance with EN 50242 (international norms.).

Programme Listing

Programme Name & Temperature	Intensive + 70°C (P1)	Intensive 65°C (P2)	Express 65°C (P3)	Eco 50°C * (P4)	Quick 40°C (P5)	Prewash (P6)
Level of Soil	High	High	Medium	Medium	Low	-
Detergent Required A=25cm ³ /15cm ³ B=5cm ³	A + B	A + B	A + B	A + B	A	-
	Prewash	Prewash	Prewash	Prewash	Prewash	Prewash
	70°C Wash	65°C Wash	65°C Wash	50°C Wash	40°C Wash	End
	Cold Rinse	Cold Rinse	Cold Rinse	Cold Rinse	Cold Rinse	
	Hot Rinse	Hot Rinse	Hot Rinse	Hot Rinse	Hot Rinse	
	Dry	Dry	Dry	Dry	Dry	
	End	End	End	End	End	
Programme Duration (min.)	124	115	50	186	30	15
Electricity Consumption (kW hour)	1.31	1.33	1.08	0.83	0.71	0.02
Water Consumption (litre)	15.1	17.6	10.5	13.0	10.0	3.5

The values and times provided above have been obtained under laboratory conditions according to relevant standards. Actual results obtained can vary depending on the conditions of the dishwasher's use and environment (mains supply voltage, water pressure, water input temperature and environment temperature).

*Laboratory measured value in accordance with European standard EN50242

Care and Maintenance

Before beginning any care or maintenance, you should always disconnect the appliance from the electricity supply, and also turn off the water supply.

Fascia

Wipe the fascia clean using just a damp cloth rinsed in a mild liquid detergent solution and well wrung out.

Door Seals

Wipe the dishwasher door seals regularly with a damp cloth to remove any residues.

Filters

You should clean the filters at least once a month.

1. Remove the lower basket.
2. Turn the microfilter anticlockwise and then lift it out (figure 16).
3. Remove the coarse filter from the microfilter (figure 17).
4. Remove the base filter from the dishwasher compartment (figure 18).

You should clean and rinse the filters thoroughly before replacing all the sections in

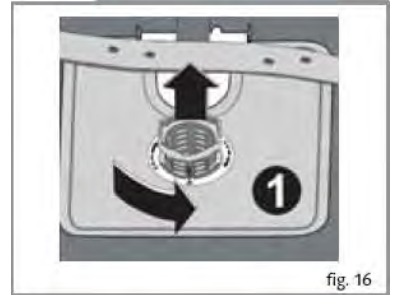

fig. 16

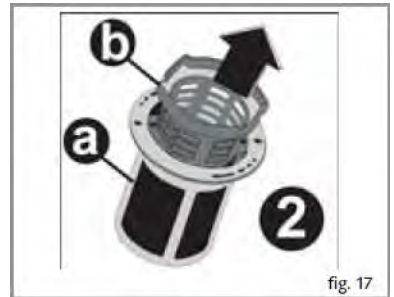

fig. 17

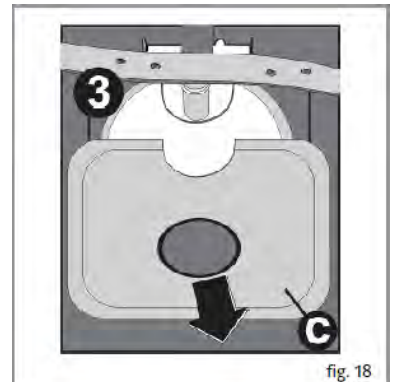

fig. 18



fig. 19

reverse order to that above. The microfilter should lock into place once it is secure (figure 19).

Please note: Never run a programme without the filters in place. Incorrect fitting of the filters may reduce wash performance and potentially damage your appliance.

Spray Arms

You should clean the spray arms at least once a month.

1. Remove the lower basket
2. Pull the lower spray arm upwards to remove it.
3. To remove the upper spray arm, first remove the nut on the upper spray arm by turning it (figure 9).
4. You should clean and rinse the spray arms thoroughly before replacing them. Ensure that the upper spray arm nut is securely tightened when refitting the upper spray arm.

To deal with an accumulation of dirt, oil or limescale in the dishwasher, run an intensive programme with detergent when the dishwasher is empty.

Alternatively, there are specialist dishwasher cleaners available that can be used.

Failure Codes and Troubleshooting

The programme indicators also serve as a diagnostic display to help in the event of a problem with the appliance.

Error Code	Error Description	Advice
F1	Alarm is active against water flow	Turn off dishwasher and disconnect water supply Contact CDA Customer Care
F2	Waste water in the machine cannot be discharged	Drain hose is blocked The filters in the machine may be blocked Restart the dishwasher and cancel the programme If the error continues contact CDA Customer Care
F3	Continual fill error	Contact CDA Customer Care
F5	Inadequate water supply	Make sure the water tap is fully open Close the water tap, separate the water inlet hose from the tap and clean the filter Restart the dishwasher If the error continues contact CDA Customer Care
F6	Faulty heater sensor	Contact CDA Customer Care
F7	Overheating error (temperature in the machine is too high)	Contact CDA Customer Care
F8	Heater error	Contact CDA Customer Care
F9	Spray diverter position error	Contact CDA Customer Care
FE	Faulty electronic card	Contact CDA Customer Care

Problem	Possible Cause
The programme will not start	Check the plug, fuse and circuit breakers of the mains supply The water tap is turned off The dishwasher door is not fully closed The water inlet filter or the machine filters are blocked
Water remains inside the dishwasher at the end of the programme	The water drain hose is blocked or kinked The filters are blocked
The dishwasher stops in the middle of a programme	Power failure Water inlet failure Programme is on standby
Wash performance is of a low standard	Poor loading of dishes hinders wash performance Insufficient detergent added Inappropriate wash programme selected Spray arm is blocked Filters clogged or incorrectly fitted Water drain pump is blocked
White stains on the dishes	Insufficient detergent added Rinse aid setting is too low Insufficient dishwasher salt added Water softener setting is too low Salt compartment cap may not be completely closed
The dishes are not completely dry at the end of a programme	A programme without a drying stage was selected Rinse aid setting is too low Dishes unloaded too soon (allow time for drying)
There are rust stains on the dishes	Different sets of cutlery should be kept separate Too much salt (water softener setting is too high) Salt compartment cap not completely closed Poor appliance earth (check mains electrical supply)
The door is not opening or closing properly	Door tension not correctly adjusted on the décor door

Electrical Information

Warning: This appliance must be earthed,

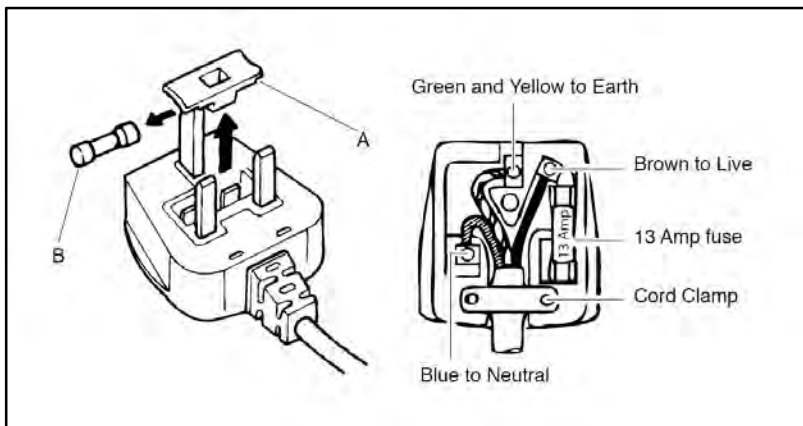

The mains lead of this appliance has been fitted with a BS 1363A 13 Amp fused plug. To change a fuse in this type of plug, follow the steps below:

1. Remove the fuse cover and fuse.
2. Fit replacement 13A fuse, ASTA approved to BS 1362 type, into the fuse cover.
3. Replace fuse cover.

Important: Do not use the appliance without the fuse cover in position.

How to Connect an Alternative Plug

If the fitted plug is not suitable for your socket outlet, then it should be cut off and disposed of safely to avoid the risk of electric shock. A suitable alternative plug of at least 13 Amp rating to BS 1363 should be used.

As the colours of the wires in the mains lead of this appliance may not correspond with the coloured markings identifying the terminals in your plug, proceed as follows:-

- The wire which is coloured GREEN and YELLOW must be

connected to the terminal which is marked with letter (E) or by the Earth symbol or coloured GREEN and YELLOW.

- The wire which is coloured BLUE must be connected to the terminal which is marked with the letter (N), or coloured BLACK or BLUE.
- The wire which is coloured BROWN must be connected to the terminal which is marked with the letter (L) or coloured RED or BROWN.

If in doubt regarding the electrical connection of this appliance, consult a qualified electrician. Do not shorten the supply cable, the appliance may require removing for servicing.

N.B. Ensure that the plug socket is situated in an easily accessible place.

Installation

- Do not install this appliance if it is damaged in any way. Installing a damaged appliance may invalidate the warranty.
- The water supply tap should be located in an adjacent cupboard so that it can be accessed after installation.
- Ensure the appliance is level by adjusting the feet as necessary. The dishwasher is equipped with an adjustable rear foot that can be raised or lowered by means of an adjustment screw, located in the centre of the kick plate.
- Only use the water inlet supplied with the appliance.
- If the water pressure is above 10 bar, a pressure relief valve should be used.
- After connecting the water supply, check to ensure there are no leaks.
- The water outlet can either be connected to a water drain or to a sink outlet spigot. This connection should be at a minimum of 50 cm and a maximum of 110 cm from the floor. The drain hose should be no longer than 4m in length to ensure good performance from the dishwasher.
- To prevent syphoning, ensure

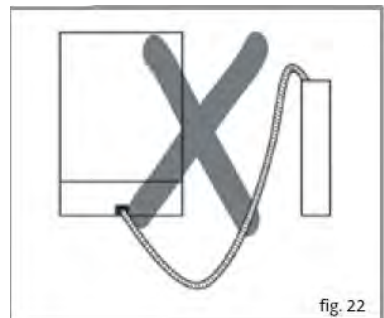
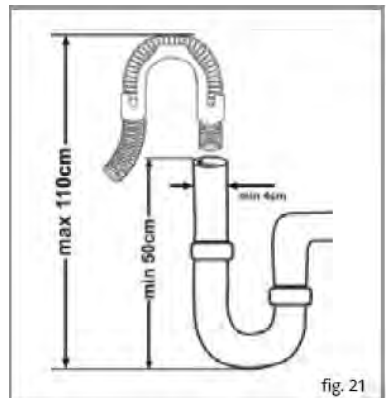

that the water outlet is not pushed too far into the waste standpipe. The lowest part of the water outlet should be level with the bottom basket of the dishwasher.

- When connecting to the sink, ensure that the waste pipe runs higher than the level of the sink bowl to prevent syphoning.

Fitting the Integrated Appliance Door

Where non-standard integrated appliance doors are supplied, additional fitting instructions are required to ensure compatibility with this product.

The machine is supplied with a fitting template and these instructions should be followed as normal.

However, the fitting template needs to be located lower down the fascia door; this is shown below.

The amount of offset, Y , depends on the height of the fascia door and can be calculated as $X = 723\text{mm}$.

For example, if you have a 731mm tall fascia door and are fitting a door to your dishwasher, then $Y = 731 - 723 = 8\text{mm}$.

Ensure that the hinge tensioners are adjusted to balance the weight of the door.

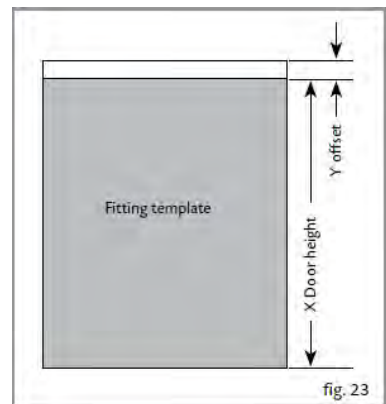



Please contact our Customer Care Department for Service on the details below

Customer Care Department • The CDA Group Ltd. • Harby Road • Langar • Nottinghamshire • NG13 9HY
T : 01949 862 012 F : 01949 862 003 E : service@cda.eu W : www.cda.eu